

MODEL
DL1100A
1100lb/499kg CAPACITY
PULLING WINCH

FRONT & SIDE VIEW

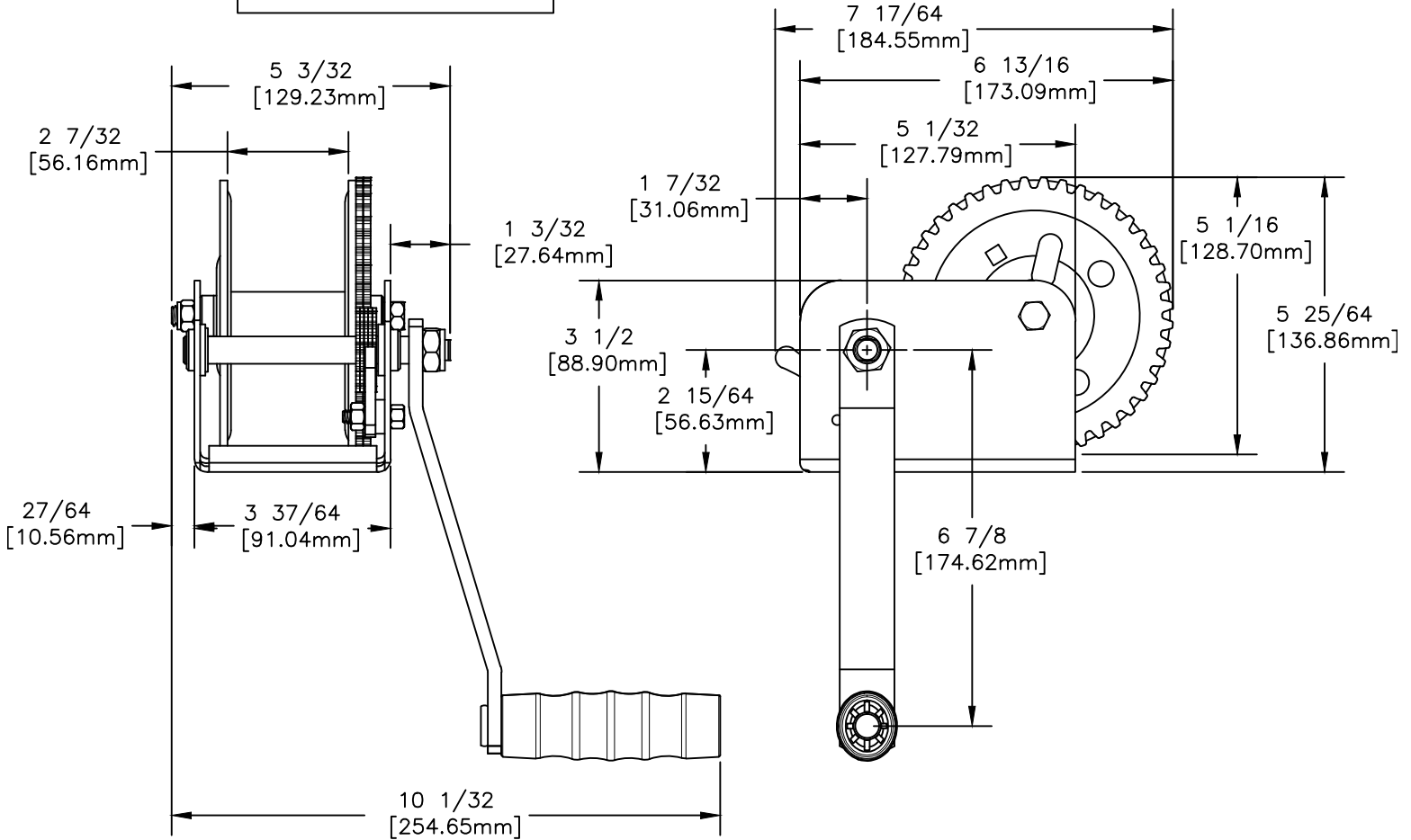

BASE HOLE PATTERN

