

MODEL
DL1602A
1600lb/726kg CAPACITY
PULLING WINCH

FRONT & SIDE VIEW

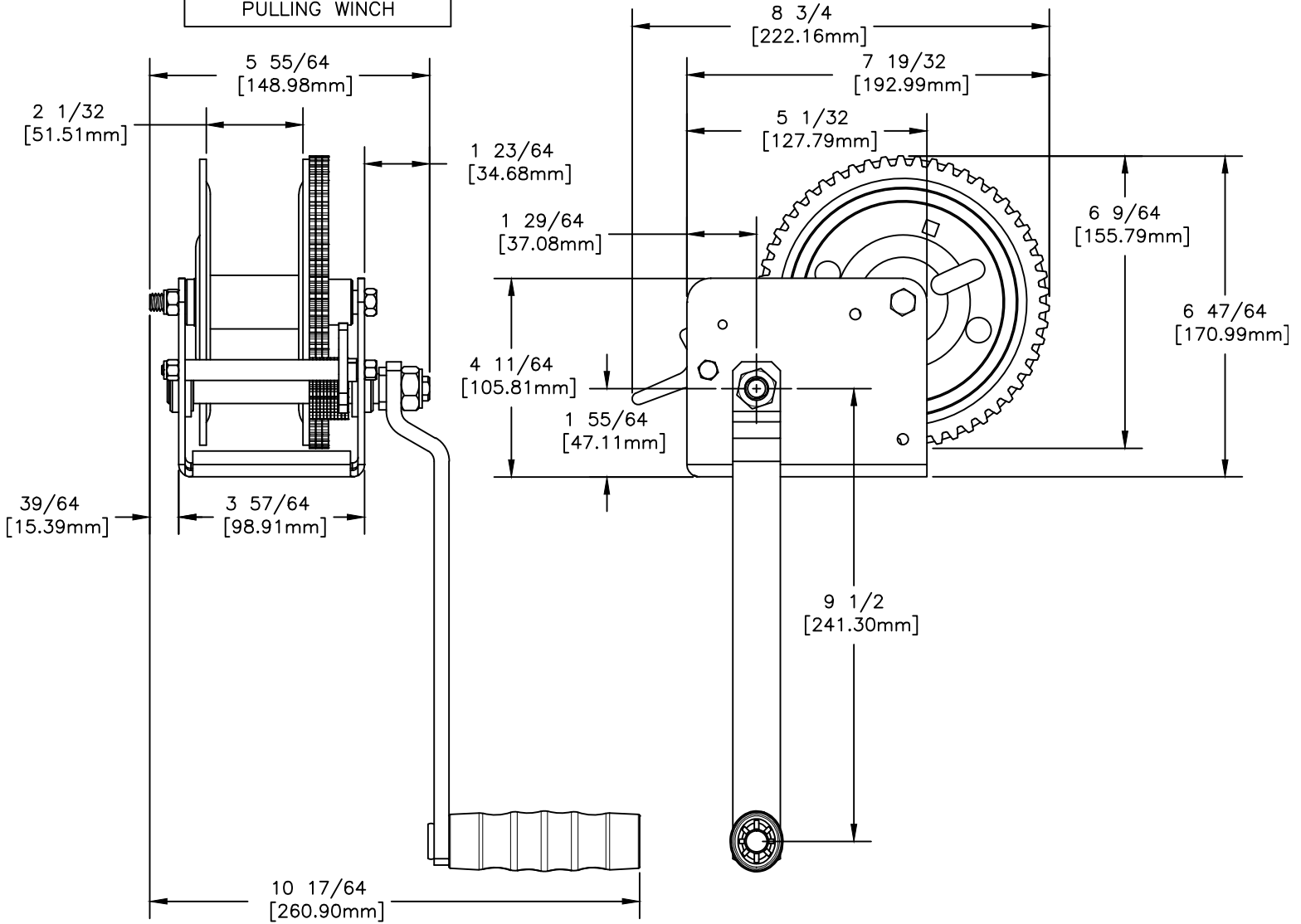

BASE HOLE PATTERN

